



WEST BENGAL STATE ELECTRICITY DISTRIBUTION COMPANY LIMITED
(A Govt. of West Bengal Enterprise)
Divisional Office: Bongaon Division
Administrative Building
Near 01 no Rail Gate, Jessore Road, Bongaon, District North 24 Parganas, Pin 743235

e-mail : dm.bongaon@wbasedcl.in

NOTICE INVITING e-TENDER

NIT No: DM/BNGD/ELECTRICAL/2024-25/03

Date 18.06.2024

The Divisional Manager, Bongaon Division, WBSEDCL invites e-tender for the materials detailed in the table below.
(Submission of Bid through Online)

Sl No	Name of The Work	Estimated Cost	Earnest Money	Period of Completion after issuance of Order	Name & Address of the Concerned office
01	Supply and delivery of 10,000 (Ten Thousand) nos of INS. PIERCE CON.(ABC) 50-70 SQ.MM. make: Raychem/ SKIC as per enclosed approved drawing of WBSEDCL. Material Code: 504026741	9,50,000/-	19,000/- (Nineteen Thousand Only)	45 (Forty Five Days)	Bongaon Divisional Store, Near Chandpara BDO (Debipur Garage), Vill-Debipur, P.O.- Chandpara, Bongaon, North 24 PGS, Pin- 743245.

Terms & Conditions of the E-Tender:

1. In the event of e-filling intending bidder may download the tender document from the website <https://wbtenders.gov.in> directly with the help of Digital Signature Certificate.
2. Both Technical Bid and Financial Bid should be submitted in technical and financial folder concurrently duly digitally signed by the Tenderer through the website <https://wbtenders.gov.in>
3. Technical Document and Financial Bid should be submitted online on or before as per the "Date & Time Schedule" stated in SL No. 07 below.
4. The FINANCIAL OFFER of the prospective tenderer will be considered only if the TECHNICAL DOCUMENT of the tenderer found qualified by the Tender Inviting Authority. The decision of the Tender Inviting Authority will be final and absolute in this respect. The list of responsive and Non-responsive Bidders will be displayed in the website.

5. Eligibility criteria for participation in the Tender:

Bonafide, experienced & resourceful contractors of Govt., Semi govt., Govt. Undertaking Organizations, Govt. Enterprises etc. who have successfully completed one no (01) no. similar nature of work (supply of hardware of LT AB Cable accessories) having value not less than 80% (Eighty Percent) of the Estimated cost in a single contract or 02 nos. of similar nature of work having (supply of hardware of LT AB Cable accessories) value not less than 50% (Fifty Percent) of the estimated cost in 2 contract or 3 no. similar nature of work (supply of hardware of LT AB Cable accessories) having value not less than 40% (forty percent) of the estimated cost in 3 contract during last 07 (Seven) years.

All intending Bidders are required to produce valid copies of Professional Tax (PT) Clearance Certificate along with PAL Card / IT return as well as EPF , ESI , GST Registration Certificate(including HSN and SAC Code) & Certificate of compliance of statutory obligations (to be documented through e-filing).

6. No mobilization / secured advance will be allowed.

7. Date & Time schedule:-

SL No	Particulars	Date & Time
01.	Date of uploading of N.I.T and Tender Documents (online). [Publishing date]	26.06.2024 after 10.00 Hrs
02.	Documents sell / download start date (online).	26.06.2024 after 10.00 Hrs
03.	Bid Submission / upload start date (online)	26.06.2024 after 10.00 Hrs
04.	Bid Submission /upload end date (online)	02.07.2024 after 17.00 Hrs
05.	Date for opening of Techno-Commercial bid (online) for the Bidders	05.07.2024 at 14.00 Hrs
06.	Date of uploading the Final List of Technically Qualified Bidders after Techno-Commercial Bid Evaluation (online).	To be intimated later.
07.	Date, for opening of Financial Bid (online).	To be intimated later.

- If a Holiday falls on any of the aforesaid scheduled date then scheduled date shall be considered on next working day.

8. Bids shall remain valid for a period not less than 120 (One hundred twenty) days after date of Bid opening of tender. Bid valid for a shorter period shall be rejected by the Tender Inviting Authority as non-responsive. If the Tenderer withdraws the bid before the period of bid validity without giving any satisfactory explanation for such withdrawals, the earnest money as deposited will be forfeited forthwith without assigning any reason thereof.

9. Earnest Money/ Bid Guarantee: A bidder desirous of taking part in a tender invited by offices of WBSEDCL shall login to the e- Procurement portal of Government of west Bengal <https://wbtenders.gov.in> using his login Id and password. The bidder shall select the tender to bid and initiate payment of EMD @ 2% (two per cent) of the pro-rata tendered amount of the offered quantity amounting to **Rs. 19,000.00** only and be submitted individually along with the offer. Exemption from deposition of EMD shall not be allowed under any circumstances. No Interest shall be payable by WBSEDCL on the above bid guarantee.

Following payment options are available for paying EMD amount through online mode:

- Net-banking through Payment Gateway
- RTGS/NEFT Payment: On selection of RTGS/ NEFT as the payment mode, the e-Procurement portal will show a pre-fired challan having the details to process RTGS/NEFT transaction. The bidder will print the challan and use the prefilled information to make RTGS/NEFT-1 payment using his bank account. Once the payment is made, the bidder will come back to the e-procurement portal to continue the bidding process after expiry of a reasonable time to enable the RTGS/NEFT process to be completed.

EMD amount needs to be paid in online mode only. Any other mode of payment will not be accepted.

General Instructions for Online Payment:

- a. The bidder will have to mandatorily pay through Net banking facility once Net banking mode is opted for payment.
- b. Status of NEFT/RTGS payment through Challan for a bid may take time for bank settlement which is updated in 24 hours (approx). As such bidders opting to pay through NEFT/RTGS mode shall make payment well before 24 Hrs. to avoid any complicity.
- c. In case actual EMD amount as per NIT is more than the one shown in E-tender portal, bidders will have to opt for NEFT/RTGS mode (challan mode). In that case the total actual EMD amount to be paid only through NEFT/RTGS mode (challan mode).
- d. The bank account used for payment of EMD by the bidders shall be maintained operative until the completion of tendering process. All refunds will be made mandatorily to the bank A/c from which the payment of EMD has been initiated.

10. Refund/Settlement of EMD Amount:

- a. For unsuccessful bidders, EMD amount submitted against the tender shall be refunded automatically, through an automated process, by NIC portal on receipt of updated status of any bid.
- b. For successful bids, EMD will be refunded from WBSEDCL authority after completion of tendering process and following due procedures.
- c. The bank account used for payment of EMD by the bidders shall be maintained operative until the completion of tendering process. All refunds will be made mandatorily to the bank A/c from which the payment of EMD has been initiated.
- d. For any queries related to payments and refunds, bidders will have to communicate with ICICI customer Support, viz, 033-40267512/13, since payment gateway facility used by E-tender portal is maintained by ICICI.

11. The intending Bidders shall clearly understand that whatever may be the outcome of the present invitation of the Bid, the Tender Inviting Authority reserves the right to accept or reject any / all offer without assigning any reason whatsoever and is not liable for any cost that might have incurred by the Bidder at the stage of Bidding.

12. Prospective applicants are advised to note carefully the minimum qualification criteria as mentioned in "**Instruction to bidders**" stated in section— "A" before tendering the bids.

13. Work Order & Payment of work will be depended on availability of fund. Intending bidders may consider this criteria while submission of tender and quoting their rate through online.

14. No Conditional Bid / Incomplete Tender will be accepted under any circumstances.

15. At any stage during scrutiny, if it is found that the credential or any other papers which the Bidder uploaded during Bidding process, found incorrect / manufactured / fabricated, that bid will be considered a nonresponsive and outright rejected with forfeiture of Earnest Money and action will be taken as per stipulation of IT Rules in force.

16. Before issuance of Letter of Acceptance / Work order/ Purchase Order, the tender accepting authority may verify the credential & other documents of the lowest bidder so uploaded online if found necessary. If it is found such document incorrect / manufactured / fabricated, Letter of Acceptance / Work order will not be issued in favor of the bidder under any circumstances and action will be taken accordingly.

17. The Tender Inviting Authority reserves the right to cancel the NIT due to unavoidable circumstances at any time and no claim in this respect will be entertained.

18. The company shall in no way be held responsible or liable for any accident, miss hap of any worker during the execution of the work, any loss or damage cause to any equipments of WBSEDCL during execution shall have to be compensated in full as per direction of the Tender Inviting Authority.

19. Standard safety norms as prescribed in the rules and regulations of WBSEDCL have to be rigorously followed.

20. Penalty of ½ % per week of delay or part thereof subject to maximum of 5 % of the ordered value will be charged on the bill for non completion of work in time. The mobile number of the bidders has to be mentioned.

21. The bidders need to have necessary electrical license and documents, obtained from the Appropriate Authority, to execute work of mentioned voltage grade.

22. Other information as well as terms and conditions, which are not covered above, will be available in Instructions to Bidders, General Conditions of Contract of this tender along with the Revised Purchase Policy and Civil Works policy of WBSEDCL.

23. Price Bid of a bidder will be considered only if his Techno-commercial Bid is found acceptable by WBSEDCL. Decision of WBSEDCL will be final and absolute/binding in this respect. The list of techno-commercially qualified bidders will be displayed in the said website in due course.

24. Any bidder against whom FIR/Complaint is lodged with Police by WBSEDCL shall not be eligible to participate in the bidding process.

25. If the offer is submitted without or inadequate Earnest Money, the bid will not be opened. In case of incomplete offer, the tender will be liable for rejection and Earnest Money Deposit will be forfeited.

26. Any evidence of unfair Trade Practices including over charging, price fixing, cartel etc. as defined in various statutes, will automatically disqualify the bidders.

NOTE:

- 1. WBSEDCL reserves the right to reject or accept any bid or part thereof or all bids received at its sole discretion without any reasons whatsoever.**
- 2. WBSEDCL is not necessarily bound to accept the lowest offer.**
- 3. Submission of Bidding Documents will not be constructed to mean that such bidder is automatically considered qualified.**
- 4. Tender submitted after expiry of scheduled date and time shall not be considered.**

Section- A

INSTRUCTION TO BIDDER

A. General guidance for e-tendering

Instructions/Guidelines for tenders for electronic submission of the tenders online have been annexed for assisting the contractors to participate in e-tendering.

1. Registration of Contractor:

Any contractor willing to take part in the process of e-tendering will have to be enrolled and registered with the Government e-procurement system, through logging on to <https://wbtenders.gov.in> (the web portal). The contractor is to click on the link for e-tendering site as given on the web portal.

2. Digital Signature Certificate:

Each contractor is required to obtain a class-II or class-III Digital Signature Certificate (DSC) for submission of tenders, from the approved service provider of the National Informatics Centre (NIC) on payment of requisite amount. Details are available at the Web Site stated in Clause-2 of Guideline to bidder DSC is given as a USB e-token.

3. The contractor can search and download NIT and Tender documents electronically from the computer once he logs on to the website mentioned in clause 2 using DSC. This is the only mode of collection of Tender documents.

4. Submission of Tenders:

Tenders are to be submitted through online to the website in two folders at a time for each work, one in Technical Proposal & the other in Financial Proposal before the prescribed date & time using the Digital Signature Certificate (DSC). The documents are to be uploaded (virus scanned copy) duly Digitally Signed. The documents will get encrypted (transformed into non readable formats).

Technical proposal:

The Technical proposal should contain scanned copies of the following documents

1) Non Statutory / Technical Document Cover file Containing:

- a. Copy of I.T. return for last 3 (three) financial years, PAN.
- b. GSTIN.
- c. Company Registration No. (If bidder is company),
- d. Professional Tax Clearance Certificate / Professional Tax (PT) deposit receipt challan, if any for the last month.
- e. Trade License.
- f. Registered HSN/ SAC Code as applicable against quoted item.
- g. Self attested Documentary evidence(s) regarding fulfillment of Commercial eligibility criteria as per clause no. 5.0 of "Terms & Conditions of the E-Tender".

- a) A pre bid meeting shall be arranged by WBSEDCL in which all the bidders will be requested to attend.
- b) If there be any discrepancy or obscurity in the meaning of any clauses of the bid document or if there be any query of the intending bidder, the bidder may submit their queries to the tendering authority before specified date. Any changes in date shall be intimated to the bidders through e-mail or fax, telephone.
- c) Non-attendance at the pre bid discussion will not be a cause for disqualification of bidders.
- d) The clarification given in the pre bid discussion shall be final and binding on the bidder, being a part of the original bid documents.
- e) Pre Bid proceedings, if any, shall be circulated among all bidder by e-mail.

6. Bid Submission:

Bids shall be submitted online within the stipulated deadline. WBSEDCL may at its discretion, extend the deadline of bid submission by issuing an amendment. In that case all rights and obligations of WBSEDCL and the bidders previously subject to the original deadline shall thereafter be subject to the new deadline as extended.

7. BID WITHDRAWAL/ MODIFICATION:

The bidder may modify or withdraw his bid after submission but within the deadline of bid submission, provided written notice of the modification/withdrawal is received by WBSEDCL prior to the deadline for bid submission. No bid shall be modified/ withdrawn after the deadline of bid submission. Modification /withdrawal of bid by any bidder after the deadline of bid submission shall result into forfeiture of EMD.

8. BID OPENING

- a. Techno-commercial bids shall be opened only for those bidders whose EMD has been found in order. Bidder's representatives with written authorization (max. 2 persons per bidder) may attend bid opening. No electronic recording shall be permitted during bid opening.
- b. WBSEDCL will scrutinize and evaluate techno-commercial bid. After that, the list of techno-commercially qualified bidders and date & time of price bid opening will be notified in the web portal.
- c. WBSEDCL may, at its discretion, extend the key dates of the bid or cancel the entire bidding process.

The bidder shall have to go through all the "Annexure" enclosed in this bid document and submit the filled in proforma of the appropriate/relevant annexure with the bid document putting the signature with seal of the Company before uploading the tender.

Price bid should contain the priced "Bill of Quantities" (BOQ) in one cover (folder). Bidder is to quote the rate in the space marked for quoting rate in the BOQ.

Opening of Technical proposal:

Technical proposals will be opened by the Divisional Manager, WBSEDCL, Near 01 no Rail Gate, Jessore Road, Bongaon, District North 24 Parganas, Pin 743235 and his authorized representative electronically from the website stated using their Digital Signature Certificate (DSC).

- a) Intending tenderers may remain present if they so desire.
- b) Summary list of technically qualified tenderers will be uploaded online.
- c) Pursuant to scrutiny & decision of the Department, the list of eligible tenderers will be uploaded in the web portal.

VALIDITY OF BIDS:

Price bid of the tender shall be opened after opening of "Techno- Commercial Bid & EMD". Bids shall remain valid for a period of 120 days from the next day of opening of the tender.

Earnest Money Deposit (EMD):

The bidder shall deposit the requisite earnest money online.

The bid guarantee/EMD shall be forfeited:

If during the period of validity specified by the bidder, the bidder withdraws/modifies its bid as a whole part.

If bidder deviates from any clarification/confirmation given by him subsequent to submission of this bid.

In case of successful bidder, if bidder fails to accept LOI/Order unconditionally and sign contract to furnish the contract performance bond.

Financial Proposal:

The financial proposal should contain the documents in one cover (folder) i.e. Bill of Quantities(BOQ). The contractor is to quote the rate online through Computer in the space marked for quoting rate in the BOQ. Only downloaded copies of the above documents are to be uploaded virus scanned and digitally signed by the contractor.

5. Pre- Bid Meeting:

d. WBSEDCL reserves to instruct the bidders to submit hard copy of any relevant document (and to produce the original documents for verification) during scrutiny & evaluation of bids. Bidder's failure to comply with such instruction may lead to rejection of bid.

9. PROCESS TO BE CONFIDENTIAL:

- a. After the opening of bids, information relating to the examination, clarification, evaluation and comparison of bids, and recommendations concerning the award of contract shall not be disclosed to bidders or other persons not officially concerned with such process.
- b. Any effort by a bidder to influence WBSEDCL or other connected in the process of examination, clarification, evaluation and comparison of bids, and in decisions concerning the award of contract, may result in the rejection of his/their bid.
- c. Formation of any Cartel, may lead to the cancellation of tenders with penal measures as necessary and WBSEDCL reserves the right to take such unilateral decisions without further notice to anymore.

10. Right to Reject Bids:

WBSEDCL reserves the right to accept or reject the bid, wholly or partly, or to split the work in parts and to add or delete any of the items, without assigning any reason whatsoever.

11. Cost of Bidding:

The bidder shall bear all cost associated with the preparation and submission of his bid and WBSEDCL in no case shall be responsible or liable for this cost, regardless of the conduct or the outcome of the bidding process.

12. Determination of Responsiveness:

Prior to the detailed evaluation of the bid, WBSEDCL will determine whether the Bid is substantially responsive to the requirement of the bidding document.

For the purpose of this clause, a substantially responsive bid is one which confirms to all the terms, conditions and specifications of the bidding document, without material deviation, or reservation.

WBSEDCL's determination of bids responsiveness shall be based on the contents of the bid itself without recourse to extrinsic evidence.

If a bid is not substantially responsive to the requirements of the bidding documents, it may be rejected by WBSEDCL and the same cannot subsequently be made responsive by the bidder by correction.

13. Correction of Errors:

If there be a discrepancy between the unit price and the total price that is obtained by multiplying the unit price and quantity, the unit price shall prevail and total price shall be corrected.

If there be a discrepancy in figure and word, the total amount stated in word shall prevail.

Note: failure of submission of any of the above mentioned documents will render the tender liable to be rejected for both statutory & non statutory cover.

THE ABOVE STATED NON-STATUTORY / TECHNICAL DOCUMENTS SHOULD BE ARRANGED IN THE FOLLOWING MANNER

Click the check boxes beside the necessary documents in the My Document list and then click the Tab "Submit Non Statutory Documents" to send the selected documents to Non-Statutory folder.

Next, click the tab "Click to Encrypt and upload" and then click the "Technical" Folder to upload the Technical documents.

Sl. NO.	Category Name	Sub-category Description	Details
01.	Certificates	Certificates	a) PAN Card. b) Copy off.T. return for last 3 (three) financial years. c) GSTIN. d) Company Registration No. (If bidder is company). e) Professional Tax Clearance Certificate / Professional Tax (PT) deposit receipt challan. if any for the last month. f) Trade License g) Registered HSN/ SAC Code as applicable against quoted item.

5. No interest shall be payable for Earnest Money.

6. Any extraneous conditions will be treated as non-responsive.

7. The Bids must be submitted in prescribed proforma only.

8. Formation of any Cartel, may lead to the cancellation of tenders with period measures as necessary and. WBSEDCL reserves the right to take such unilateral decisions without further notice to anyone.

9. Bidders shall ensure that all pre-requisites are duly fulfilled by them and if there be any dispute regarding non-submission of any document, WBSEDCL reserves the right to cancel the Bid unilaterally without assigning any reasons whatsoever.

10. The bidder is expected to examine carefully all instruction, conditions, forms, schedules terms, annexure, specifications and drawings of the bidding document. Bids, which are determined to be not substantially responsive to the requirement of the bidding document, may lead to rejection.

	Company Detail(s)	Company Detail	
02.	Credentials	Credential	Requisite Credential Certificate for completion of at least 1 no. similar nature of work having value not less than 80% (Eighty percent) of the estimated cost in a single contract or 2 no. similar nature of work having value not less than 50% (Fifty percent) of the estimated cost in 2 contract or 3 no. similar nature of work having value not less than 40% (Forty percent) of the estimated cost in 3 contract during last 7 (Seven) years. Documents of Credential (in the form of work completion certificates/ payment certificates) of executing similar nature of works
03.	Financial Information	Financial Information	a) Copy of IT returns for last 3 financial years. b) Annual Audited Financial Report for last 3 years to be submitted for verification in respect of bidders for whom Audit of Accounts is mandatory. For whose Audits of Accounts is not mandatory, they shall submit copy of IT returns along with related enclosures (Form 3CA and Form 3CB) for last 5 years. [Non-statutory documents]

14. EVALUATION AND COMPARISON OF BIDS:

On examination of documents submitted under different covers, WBSEDCL will evaluate and compare the bid, determined to be substantially responsive at each step. Evaluation of bid will include and will take into account. WBSEDCL shall evaluate and compare only the bids determined to be substantially responsive. The bids shall be evaluated on the basis of total price for the entire scope of work covered under this bid document.

Evaluation bid— price of all bidders shall be compared among themselves to determine the lowest evaluation bid and as a result of this comparison, the lowest bid will be selected for award of contract. Conditioner rebate, if any, offered by any bidder shall not be considered in Bid evaluation.

15. PROCEDURE OF EVALUATION:

Evaluation of e-tenders will be done in the following steps:

Step-1 the Earnest Money will be examined. The mode and amount of deposit must be in conformity with requirements set forth in the "Earnest Money" clause, failing which the bid is liable for rejection without opening other covers.

Step-2 Techno-Commercial Evaluation for two part bidding: Only those bids meeting the requirements of previous step will be examined and assessed. The bidders will be intimated about the non-compliance of various techno commercial requirements and asked for conforming compliance with the condition of bidding document. In case, it is felt necessary by WBSEDCL that post bid discussion are required, the same will be carried out individually with each bidder. The bidders will be required to confirm compliance with all the conditions of bidding document. Bids, which do not satisfy the "Must Conditions", will not be considered for technical evaluation. "Must Conditions" are to be submitted as per format enclosed with this section. No clarification will be asked from the bidder in this regard.

Step-3 Opening of price part and financial evaluation on completion of techno-commercial evaluation. Cover containing price offer of the bidders who have successfully made the requirements of previous steps will be opened in presence of the bidder's representative (maximum two) on subsequent pre-intimated date. Price bid of the bidders who do not fulfill the Techno- Commercial requirements shall not be opened.

16. CORRESPONDENCE: Any notice to the contractor under terms of the contract shall be served by register mail or by hand at the contractor's principal place of business. Any notice to the owner shall be served at the owner's principal office in the same manner.

17. No agent is allowed to participate in the Tender. Original bidder will only be allowed in the tender.

18. Acceptance of Tender:

On opening of Techno-Commercial Bids (Part-I) the same shall have to be evaluated both in technical

and commercial aspects, the tenderers whose offers are found to be acceptable may be considered for opening of their respective price bids (Part-II). If there may be found any dispute regarding non-submission of any documents, Annexure, Tender Fees or earnest money, WBSEDCL reserves the right to cancel that bid ultimately without assigning any reason whatsoever. WBSEDCL is not bound to accept the lowest tender and reserves the right to cancel any or all the tenders unilaterally.

19. Rate:

The rate should be quoted inclusive of delivery charges but excluding GST. The rate is Firm for entire delivery period. No escalation of rate, if any, may be considered except in the event of any new taxes/levies making into force due to Govt. Legislation/notification or by any of the statutory body, the same will become applicable to the concerned party from the effective date.

20. No price preference will be allowed to any tenderer based on the size of the industries or its geographic location. Cooperative Society will not be considered with separate status.

21. payment on submission of bill after completion of delivery would be made by concerned authority. Bill along with signed challan to be submitted in triplicate mentioning in each the GST registration number and HSN/SAC code along with the items to the DIVISIONAL MANAGER, Bongaon Division for payment by the manager (F&A), Bongaon Division in due course. Payment will be made subject to availability of fund and deductions of security deposit if any required as per law.

22. Any further information may be had from the website: www.wbsedcl.in, <https://wbtenders.gov.in> and the following office time to time.

Section –B

GENERAL CONDITIONS OF CONTRACT FOR SUPPLY AND DELIVERY OF EQUIPMENT MATERIALS

1. Any contractor willing to take part in the process of e-Tendering will have to be enrolled and registered with the Government e-procurement system, through logging on to <https://wbtenders.gov.in> (the web portal). The contractor is to click on the link for e-Tendering site as given in the web portal.
2. The intending bidder(s) required to quote the rate item wise in the BOQ. The quoted price should be firm. There will be no price variation during the pendency of the contract period or thereafter. Bidders are in no way allowed to get any escalation of price against the contract. Price indicated in the schedule of prices deemed to include all the levies/duties/cess and all other incidents payable as per statute. Relevant Goods and Service tax rules are applicable for the work. The estimated cost is exclusive of goods and Service tax. It will be paid to the appropriate authority/ agency as per prevailing rates and rules in force.
3. WBSEDCL, who do not bind itself to accept the lowest tender, reserves the right to accept or reject any bid and to annual the bidding processes and reject all bids at any time prior to the Award of Contract without thereby incurring any liability to the affected Bidder or Bidders or any obligation to inform the affected bidder or bidders of the ground for WBSEDCL's (Tender Accepting Authority) action.
4. Canvassing in connection with tenders is strictly prohibited and the tenders submitted by the contractors, who resort to canvassing will be liable to rejection.
5. Bids shall remain valid for a period less than 180 (One Hundred Eighty) days after date of Bid opening of tender.

6. Security Money:

The successful Tenderer within 7 (seven) days of receipt of LOI/order. Shall submit his unconditional acceptance in writing failing which the department shall have the right to terminate the LOI/ order as per rule and earnest money, submitted along with the tender will be forfeited. On receiving tenderer's acceptance for delivery of the material the earnest money deposited with the tender will be automatically converted to form a part of security money deposited. An additional sum of security money, if required, shall be deposited by the Tenderer to constitute initial security money of 2% (two percent) of the ordered value. Further additional security money shall be deducted from the progressive bills at 8% (eight percent) of each such bill so that the total deduction together with 2% (two percent) security money already taken shall constitute not less than 10% (ten percent) of the total value. All security money shall be refunded after expiry of the period of maintenance which shall be 12 (twelve) months normally, if not otherwise mentioned.

7. Sample Inspection & Testing:

One unit sample of the item is to be submitted at Bongaon Division Office physically within the closing date and time of tender as a part of Techno-Commercial qualification and those manufactures will be allowed for further evaluation whose sample will be in order. Those who do not submit sample within

the closing date and time of tender would eventually be rejected right away. The tag with the sample should contain the name of the sample as well as the name of the vendor/ name of the bidder. For valid Tender, sample has to be approved by the Divisional Authority. The approval or rejection of sample will be communicated via mail/ electronically subsequently. The technical evaluation of the bidders, whose samples are not approved, will not be opened and henceforth they will be deemed disqualified. Rejected samples can be taken away. After LOA is awarded the awardees, can adjust the sample with the delivered material lot and the remaining materials can be taken back by the respective vendors. In terms of accepting or rejection of sample, decision of Divisional Tender Committee/ WBSEDCL would be treated as final.

a. Before finalization of tender:

After opening of the Techno-Commercial part of the tender, the tendering authority on its discretion may send their respective for inspection of the factory premises at any day within working hrs. to ensure participating tender's manufacturing capability and technical eligibility with WBSEDCL's requirement.

b. After finalization of tender:

The material shall be subjected to tests as per relevant Indian standard and as per our technical specification. If the Indian Standard has the provision of routine tests, each material/equipment shall be subjected to those routine tests. In all cases, while offering, test reports indicating the test results should be submitted to the inspecting authority of the company as will be indicated in the Purchase Order.

However, WBSEDCL reserves the right to depute its Engineers for carrying out inspection and testing on the offered lot as per relevant Indian Standards and Technical Specification and also reserves the right to reject either raw materials or finished products found to be not complying with the requirement of the specifications and standards. The supplier shall have at least 15 days prior intimation about the readiness of the material at the works for testing and inspection. The supplier shall extend all facilities for such inspection and testing for which no extra shall be charged and the inspection report shall have to be signed jointly otherwise the offered lot(s) shall be treated as cancelled.

WBSEDCL reserves the right to carry out in-house testing of the supplied materials at destination stores in presence of the authorized representative of the Manufacturer. In any case they do not be present, company shall test unilaterally and their result will be binding on them. In case the test results deviate from the inspection result carried out at the Manufacturer's Works (more than 2% tolerance as per Indian Standard wherever applicable) the company reserves the right to cancel the specific lot and in that event materials are to be replaced by the manufacturer free of cost including transportation from site to their works and back.

Dispatch & Delivery:

The supplier after receiving the dispatch clearance from the respective inspection Authority/ Purchaser shall deliver the equipment/materials suitably packed to the stores located at **Bongaon Divisional Store, Near Chandpara BDO (Debipur Garage), Vill- Debipur, P.O.- Chandpara, Bongaon, North 24 PGS, Pin- 743245** as instructed. The materials are to be booked by road only and the same should be suitable

packed and fully insured against all risks and deliver the consignment as per dispatch instructed to be communicated in due course. Immediately after dispatch of materials/equipments by road, the supplier shall notify the purchaser and consignee officer so that the consignment can be taken delivery at destination.

The date of receipt of offer for inspection of the materials/ equipments along with the works test certificate will be treated as the date of delivery of the particular lot provided the materials pass in inspection and testing. Delay in offer beyond the delivery schedule to be incorporated in the order shall attract in position of L.D as L.D. clause.

The materials delivered to consignee store will be subjected to re-inspection/re-testing in presence of authorized representative of suppliers for which due notice in advance will be furnished by competent Authority. If any discrepancy/dispute in quality arise in any sample selected from a lot, the supplier shall have to replace the specific lot at the supplier's cost and WBSIEDCL reserves the right to take any penal action whatsoever without any further reference.

8. Repeat order:

With due consent of the supplier, the WBSIEDCL may place repeat order within a period of six (06) months from the date of completion of delivery as per order to cover approximately 50% of the order quantity on successful performance of the contract and on the need of WBSIEDCL, on the basis of existing rates, terms and conditions.

The repeat order may also be placed within one year from the issuance of original order subject to successful completion of delivery as per the order to extend of at least 75% of the quantity ordered.

9. Defect Liability period:

The term "Defect Liability Period" shall mean the period of 12 (twelve) months from the date of completion of the delivery. If any defect is found within the defect liability period, the contractor shall be liable to rectify/replace the materials at their own cost and responsibility. Defects/ Rectification work so notified shall have to attended and completed satisfactory within 15 (Fifteen) days. For faithful & due fulfillment of all obligations, this defect liability period shall be covered by the security money already retained from the contractor. After completion of Defect Liability Period, and on completion of satisfaction rectification of defect, if any reported within the defect liability period, and on receipt of the application from the contractor, controlling officer of the work shall recommend for the refund of security money.

10. Cancellation/ termination of Order (if placed):

the time period for effecting complete supply and delivery of the above materials/ equipment as indicated through the delivery schedule shall have to be treated as the essence of the contract. The company reserves the right to repudiate the contract if the above period is not strictly adhered to. In the event of failure in effecting the desired supply and delivery of the above equipment/materials within due date, the above order may be cancelled on submission of necessary notice in this regard and fresh order may be placed on the next bidder or on any other bidder, as a result of which the extra cost thus

liable to be incurred shall be realized from the original supplier's pending bills which may be lying with the WBSEDCL.

11. Quality Assurance Programme:

Immediately on receipt of this order you have to submit a "Quality Assurance Plan" indicating the specific quality control procedure and practices adopted in the major activities of production to ensure its standard.

12. Force Majeure:

The supplier shall be under no liability if he is prevented from carrying out any of his obligations by reason of war, invasion, act of foreign country, hostilities (whether war declared or not), riots, civil commotion, mutiny, insurrection, rebellion, revolution, accident, earthquake, fires, floods Govt. order and/or restrictions (except power supply restriction) delay or inability to obtain materials due to import or other statutory restriction and other cause beyond the reasonable control of the supplier. However, such force majeure circumstances are to be intimated immediately and to be established subsequently with proper documents/ proofs to the entire satisfaction of the purchaser.

13. Liquidated Damage for Delay in Delivery:

The time of delivery (successful offer for inspection) of the equipment/materials are to be treated as an essence of the contract and the WBSEDCL reserves the right to repudiate the contract, if the equipment/materials are not offered for inspection within scheduled delivery period and physically delivered within stipulated period as per physical delivery clause. But the Divisional Manager, Bongaon Division, WBSEDCL may at his discretion waive this condition and accept the material with imposition of liquidated damage @ ½ % (half percent) of the value of the materials of the particular lot offered for every week or part of a week which shall elapse between the time prescribed or extended time as the case may be and the date of physical delivery of equipment/materials subject to a **maximum of 5% (five percent) of the particular lot and accept the goods beyond the stipulated period.** The company may, without prejudice to any other method of recovery, deduct the amount of such damages from any money in their hand due or which may become due to the contractor and any other contract or source also. The payment for deduction of such damages shall not relieve the contractor from his obligation to delivery of equipment/materials or from any other his obligations and liabilities under the contract.

14. Goods & Services tax (GST):

GST at prevailing rate will be paid extra.

15. Extension of Time:

An extension of time without imposition of liquidity damage, may be granted for delay in execution of work provided there is no fault whatsoever on the part of the contractor. Such extension may only be granted on the basis of application to be submitted timely (within schedule time of completion by the contractor who has to establish that the extension of time required by him is not due to his fault.)

16. Consignee Officer:

The Store-in-Charge, Bongaon Divisional Store, WBSEDCL shall be the Consignee Officer for the above mentioned work.

17. Supervising Officer:

The Divisional Engineer (tech), Bongaon Division, WBSEDCL will be the Supervising Officer for the above mentioned work.

18. Paying Officer:

The Assistant Manager (F & A), Bongaon Division, WBSEDCL will be the paying Officer for the above mentioned work.

19. Controlling Officer:

The DE & Divisional Manager, Bongaon Division, WBSEDCL will be the Controlling Officer for the above mentioned work.

20. Additional Liabilities:

The WBSEDCL shall not take any additional liability towards enhanced taxes, duties, and price variation beyond the scheduled delivery period as incorporated in the purchase order, if the delay is due to any failure on the part of the supplier.

21. Legal Jurisdiction:

If any dispute or difference arises with respect to quality/quantity of the equipment/materials pertaining to this order or any other terms and conditions of the order including its execution, such dispute/difference shall be subject to settlement under the jurisdiction of Courts in Kolkata only.

22. Additional Performance Security which shall be equal to 10% of the tendered amount must be furnished by the successful bidder if the accepted bid value is 80% or less of the estimate put to tender. The additional Performance Security shall be submitted in the form of Bank Guarantee from any scheduled bank valid for a period of 1 (one) year, as per specified format marked 'Annexure - A' enclosed with this NIT, before issuance of the Work Order. If the bidder fails to submit the additional performance security within 07 (seven) working days from the date of issuance of letter of acceptance, his earnest money will be forfeited and other necessary action as per NIT like blacklisting of the contractor etc. may be taken. The bank guarantee shall have to be valid up to end of the contract period and shall be renewed accordingly if required. The bank guarantee shall be returned immediately on successful completion of the contract. If the bidder fails to complete the work successfully, the additional performance security shall be forfeited at any time during the pendency of the contract period after serving proper notice to the contractor. This is in compliance of the terms of Memorandum No. 4608-F(Y) dated 18.07.2018 of the Finance department, Government of West Bengal.

23. Bid specified Authorization letter is required mandatory from the (OEM).

24. Performance Certificate is mandatory for previous experience.

18/06/24
Divisional Engineer (Tech)
Bongaon Division
W.B.S.E.D.C.L.

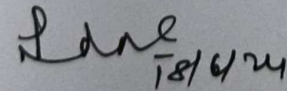
18/06/24
Assistant Manager (F&A)
Bongaon Division
WBSEDCL

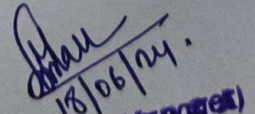
18/06/24
Divisional Manager
Bongaon Division
W.B.S.E.D.C.L.

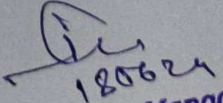

18/06/24
Divisional Manager
Bongaon Division
W.B.S.E.D.C.L.

NOTES:

1. STANDARD: NFC 33 020
2. CABLE RANGE: MAIN: 16-96 Sq.mm
TAP: 1.5-10 Sq.mm *7.5 to 10mm*
3. BREAKING SHEAR HEAD TORQUE: *8 TO 10 Nm*

SONAL
Addl. Chief Engineer
Dist. Project-III
W.B.S.E.D.C.L.

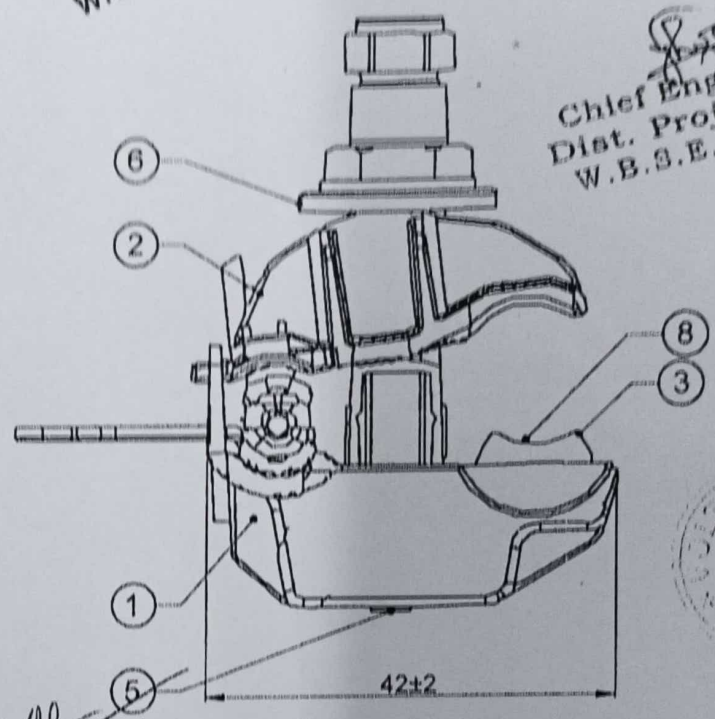
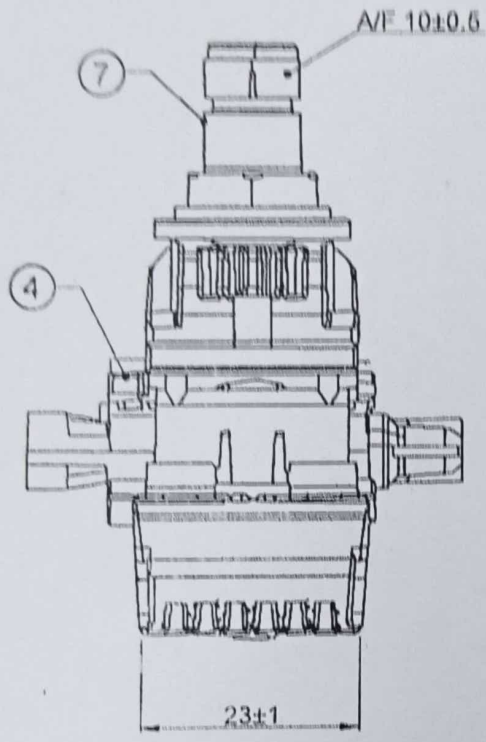
May be accepted subject to acceptance / incorporation of necessary suggestions as mentioned by us.



SONAL
Chief Engineer
Dist. Project-III
W.B.S.E.D.C.L.

SONAL
Divisional Engineer (Elect.)
Dist. Project-III
W.B.S.E.D.C.L.



PROJECT	STRENGTHENING OF EXISTING SUB-TRANSMISSION & DISTRIBUTION NETWORK IN URBAN AREA OF NORTH 24 PGS & BURDWAN DIST. OF WEST BENGAL UNDER INTEGRATED POWER DEVELOPMENT SCHEME (IPDS)	
OWNER		WEST BENGAL STATE ELECTRICITY DISTRIBUTION CO. LTD.
CONTRACTOR		VOLTAS Ltd. Godrej Waterside Tower-2, Unit no.-803, 8th Floor, Plot No.-5, Block -DP, Sector-V, Saltlake, Kolkata-700091
LOA REF.	CEP-III IPDS LOA/PK-6/NPGS/PLY/ERECT/17-18/54/714,715 all Di. 12.07.2017 CEP-III IPDS LOA/PK-7/NPGS/PLY/ERECT/17-18/54/716,717 all Di. 12.07.2017 CEP-III IPDS LOA/PK-3/BURDWAN/PLY/ERECT/17-18/66/1241, 1242 all Di. 17.11.2017	

SR.NO.	DESCRIPTION	QTY.	UOM
8	GREASE <i>Vaseline on connecting sectn.</i>	1	NO.
7	SHEAR HEAD	1	NO.
6	WASHER	1	NO.
5	BOLT	1	NO.
4	INSULATED JOINT	1	NO.
3	CONNECTING BRIDGE	2	NOS.
2	UPPER BODY	1	NO.
1	LOWER BODY	1	NO.

ALL DIMENSIONS ARE IN MM.

THIS DOCUMENT IS THE PROPERTY OF RAYCHEM RPG PRIVATE LIMITED, VADODARA. IT MUST NOT BE LOANED, COPIED OR REPRODUCED WITHOUT WRITTEN PERMISSION.

DO NOT SCALE

Raychem RPG Pvt. Ltd. *R₂*
(A TE Connectivity - RPG Enterprises JV)

TITLE:
INSULATING PIERCING CONNECTOR

Rev	Revision Record	Date	Dwn	Appd
-----	-----------------	------	-----	------

DRAWN BY: SONAL RANA

SCALE: NTS

Customer Drawing

CHKD BY: SARAVANAN T.

SHEET SIZE: A4

Tolerance: ± 5% Unless otherwise specified

APPR. BY: S.SHIRIPAT

ISSUE DATE: 02.12.2011

REFERENCE: EP 95/ 1727912-1

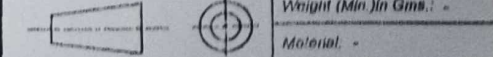

DRAWING NO.: C-AJA4040115

RESTRICTED TO:	REV DATE	REV
		0

SPECIMEN COPY OF INDEMNITY BOND
(TO BE EXECUTED ON Rs 100/- Non Judicial Stamp Paper)

BY THE PRESENT INDEMNITY BOND EXECUTED by me / us on this Day of.....I/We having Registered Office / residing at. (hereinafter called "OBLIGOR/OBLIGATOR" which expression shall mean and include my/our Successors legal representatives, assigns) do hereby binds myself / ourselves and also our Company/firm after having the power to bind so with the promise and undertaking in favor of the West Bengal State Electricity Distribution Company Limited. West Bengal State Electricity Transmission Company Limited, a government Company within the meaning of sec.617 of the Indian Company's act having registered office at Bidyut Bhavan, block-DJ, Sector-II, Salt Lake City, Kolkata-700091(hereinafter called as OBLIGEE, which expression shall mean and include it's legal representative administrators assigns. WHEREAS OBLIGOR/OBLIGATOR has /have been awarded to execute the job / works under letter no. Dated .issued by the OBLIGEE/OBLIGATOR after having observing necessary formalities the details of which is described in the schedule given hereunder as per letter mentioned herein-above and whereas the said job / works will be/likely to be done in places covered under Employees' State Insurance Act(ESI) and / or the Workmen Compensation Act(W.C. Act) and / or other laws relating to the Labour Management and Welfare. AND WHEREAS according to the condition of the contract the OBLIGOR / OBLIGATOR is under obligation to execute this Indemnity Bond before the commencement of actual execution and OBLIGOR/OBLIGATOR is aware that unless this Indemnity Bond is executed in accordance with the condition of contract before the actual execution in accordance with law the OBLIGEE shall have the power to deem that actual work has been started within the meaning of the contract before the execution of this Indemnity Bond NOW THIS

- INDENTURE WITNESSTHAT I / We the OBLIGOR/OBLIGATOR do hereby undertake.
1. THAT the OBLIGEE shall not be held responsible for any type of accident which may take place during the course of work undertaken by the OBLIGOR/OBLIGATOR.
 2. THAT the OBLIGOR/OBLIGATOR will take adopt all safety norms in respect of each and every workmen labour personnel according to the rules or to the satisfaction of the OBLIGEE in all cases.
 3. THAT the OBLIGOR/OBLIGATOR undertakes to engage only those labour worker or any other personnel whether skilled or unskilled or any other person whether in technical managerial or non-managerial or any other capacity in the area covered under Employees' State Insurance Act who has have insurance coverage within the meaning of Employees State Insurance Act and further undertakes NOT to engage any person in the area covered under the Employees State Insurance Act, who does / do has / have insurance coverage within the meaning of Employees State Insurance Act.
 4. THAT the OBLIGEE further undertakes to engage only those labour worker, or any other personnel, whether skilled or unskilled, whether in technical, managerial or non-managerial or any other capacity in the area NOT covered under Employees' State Insurance Act who has life insurance for the sum assured equivalent to the amount of Compensation under the Employees' Compensation Act in case of accidental death or inquiry and such insurance has been effected by the OBLIGEE.
 5. THAT the OBLIGOR/OBLIGATOR undertakes / undertake to indemnify and keep harmless the OBLIGEE from all claims action proceedings and of risk damage danger to any person whether belonging to/ or not belonging to OBLIGOR/OBLIGATOR.
 6. THAT the OBLIGOR / OBLIGATOR shall keep harmless the OBLIGEE from all claims compensation damages any proceedings in respect of any of its employee/workmen under the Workmen Compensation Act. Act or any other laws for the time being in force.
 7. THAT if during the course of execution of work as stated in the letter mentioned hereinabove issued by the OBLIGEE, it is found that the OBLIGOR/OBLIGATOR has not complied with/ guidelines formalities within the meaning of Employees' State Insurance Act or Workmen Compensation Act or any other laws relating to the Labour Welfare for the time being in force, and also has not observed the safety norms in accordance with the law to the satisfaction of the OBLIGEE the OBLIGEE shall have the right to stop the execution of work/job and the period of such stoppage shall continue till adequate safety and other compliance mentioned hereinabove under the labour welfare legislation have been observed and such period of stoppage shall not be taken into account for the calculation of the total period of completion of work for which the OBLIGOR/OBLIGATOR is responsible to complete the work/job and it will be deemed that discontinuance was due to default of OBLIGOR/OBLIGATOR.
 8. THAT if at any time due to exigency, the OBLIGOR/OBLIGATOR i.e. the West Bengal State Electricity Distribution Company Limited / West Bengal State Electricity Transmission Company Limited as the Principal Employer, becomes

liable to pay any such compensation mentioned hereinabove, whether on failure of the obligee or for any other reason, the OBLIGOR/OBLIGATOR shall have the right to recover the said amount from any amount receivable by OBLIGEE or any bank guarantee deposited or anything payable whether in connection with this contract or other contract by the OBLIGOR/OBLIGATOR to the OBLIGEE.

9. THAT the OBLIGOR/OBLIGATOR is/are aware and accept that for the persistent or repeated violation of any condition mentioned in this Indemnity Bond, the OBLIGEE shall have right to terminate the contract of work issued by the OBLIGEE to OBLIGOR/OBLIGATOR.

.....
Deponent

Witness:

1.....

2.....

PROFORMA OF AGREEMENT
(TO BE EXECUTED ON Rs 100/- Non Judicial Stamp Paper)

ARTICLES OF AGREEMENT made this Date of In the year..... between West Bengal State Electricity Distribution Company Limited having its Head Office at Vidyut Bhavan, Block DJ, Sector II, Kolkata-700091 hereinafter referred to as the WBSEDCL (which expression shall unless excluded by or repugnant to the context be deemed to include its successors and assigns) of the ONE PART AND hereinafter referred

to as "CONTRACTOR" (which expression shall unless excluded by or repugnant to the context be deemed to include his heirs, executors, administrators, representatives and assigns) of the OTHER PART.
WHEREAS WBSEDCL invited tenders vide Tender Notice No..... Date (annexed hereto)

for (Name of the work).....
AND WHEREAS in pursuance of such invitation for tenders the contractor submitted a tender vide no.

dt..... which was opened on
The tender offer shall be in the custody of the WBSEDCL at present.

AND WHEREAS AFTER consideration of the tender submitted by the contractor with clarification(s), if any, WBSEDCL accepted the said tender submitted by the contractor and placed order no.....
dt..... (Annexed hereto)

NOW THEREFORE, the WBSEDCL and the Contractor agree as follows :
The contractor agrees to undertake the work of as per Order No
dt..... referred to above.

The WBSEDCL agrees to pay the contractor as per the Order No..... dt..... referred to above.
Both the contractor and the WBSEDCL agree that for the purpose of jurisdiction of court in regard to any dispute arising out of this agreement, this agreement shall be deemed to have been executed within the jurisdiction of the original side of the High Court, Kolkata.

In witness whereof the parties have hereunder affixed their signature, on the day, the month and year written as above.

..... Contractor
Witness:
1.....
2.....

..... WBSEDCL
Witness:
1.....
2.....

LETTER HEAD OF BIDDER (AS ENROLLED ONLINE ON e-Tendering PORTAL OF NIC)

To

The Tender Committee

Sub: Letter of Bid for the supply of

.....
.....
.....

Ref: 1. NIT No: WBSEDCL/.....)

Dated:

2. Tender Id No:

Dear Sir,

We offer to execute the work as per our offered bill of quantity in accordance with the conditions of the NIT document as available in the website. The details of the of the EMD being submitted by us has been furnished on-line.

This Bid and your subsequent Letter of Acceptance / Work Order shall constitute a binding contract between us.

We hereby confirm our acceptance of all the terms and conditions of the NIT document unconditionally.

Signature of the Tenderer

Dated.....

MANDATE FORM BY VENDOR FOR RTGS/ NEFT PAYMENTS
(TO BE FILLED IN BLOCK LETTER)

- 1. NAME OF THE VENDOR:
- 2. ERP VENDOR NO:
- 3. Vendor Type: Company / Partnership / Proprietorship / Self Help Grp / HUF/Others (To be specified)
- 4. ADDRESS:.....
- 5. TELEPHONE NO. & FAX NO:.....
- 6. MOBILE PHONE:.....
- 7. Email:.....
- 8. P.A.N. NO. (MANDATORY):

--	--	--	--	--	--	--	--	--	--	--	--	--	--	--	--	--	--	--	--

9. GST REGISTRATION NO:

10. PARTICULARS OF BANK ACCOUNT (One cancelled Cheque is to be enclosed)

- i) Name of Account Holder:
- ii) BANK NAME:
- iii) BRANCH NAME & ADDRESS:.....
- iv) BANK BRANCH TELEPHONE NO:.....
- v) Account type (whether SB or Current):.....
- vi) ACCOUNT NO:

--	--	--	--	--	--	--	--	--	--	--	--	--	--	--	--	--	--	--	--

vii) BANK'S MICR CODE:

--	--	--	--	--	--	--	--	--	--	--	--	--	--	--	--	--	--	--	--

viii) BANK'S IFS CODE:

--	--	--	--	--	--	--	--	--	--	--	--	--	--	--	--	--	--	--	--

II. DECLARATION OF THE PARTY:

I hereby declare that the particulars given above are correct and complete. If the transaction is delayed or Not Affected at all for reasons of incomplete and incorrect information, WBSEDCL will not be held responsible.

Date:

Signature of the Vendor

PROFORMA FOR UNDERTAKING TO BE SUBMITTED BY THE BIDDER

(For genuineness of the information furnished on-line and authenticity of the documents produced before Tender Committee for verification in support of his eligibility)

I,Partner /Legal Attorney /Accredited Representative of M/s.

..... Solemnly declare that:

1. We are submitting Tender for the job/supply of.....
2. None of the Partners of our firm in relative of employees of.....
3. All information furnished by us in respect of fulfillment of eligibility criteria and qualification information of this Tender is complete, correct and true.
4. All documents/Credentials submitted along with this Tender are genuine, authentic, true and valid.
5. If any information and document submitted is found to be false/incorrect any time, department may cancel my Tender and action as deemed fit may be taken against us, including termination of the contract, forfeiture of all dues including Earnest Money and banning/delisting of our firm and all partners of the firm etc.

Signature of the Tenderer

Dated.....